



**RÖDER** T-LINE SERİSİ | T-LINE SERIES

## NEDEN RÖDER?

RÖDER Grup, yenilikçi modüler çadır sistemleri konusunda satış ve uzun dönem kiralama hizmeti veren uluslararası bir yapı sistemi uzmanıdır. Dünya çapında 30'dan fazla ülkede 600'den fazla uzman çalışanı ile birinci sınıf kalite, bilgi birikimi ve hizmet sunuyor. RÖDER, gücünü 65 yıllık deneyiminden ve uluslararası bir proje çözüm ortağı olmasından alıyor. Projeleri müşteri gereksinimlerine özel olarak uyarlayan RÖDER dünya çapında servis ve garanti hizmeti sunuyor.

RÖDER Group is an international building systems specialist offering sales and long-term rental services for innovative modular tent systems. With over 600 expert employees in more than 30 countries worldwide, it provides first-class quality, expertise, and service. RÖDER draws its strength from 65 years of experience and its position as an international project solution partner. Adapting projects to specific customer requirements, RÖDER offers worldwide service and warranty support.

### 65+

Yıllık Güven ve Tecrübe / Years of Trust and Experience

### 600+

Takım Çalışanı / Team Member

### 5.500+

Memnun Müşteri / Satisfied Customer

### 10.000+

Başarılı Proje / Successful Project

### 38.000m<sup>2</sup>+

Üretim Tesisi / Production Facility



# T-LINE

## Geniş Kullanım Alanı Sağlayan Ekonomik Çözüm

The Economical Solution for Wide Range of Uses

- Yalıtımlı veya yalıtımsız cephe seçenekleri
- Thermo-Roof çatı sistemi
- Donanım seçenekleri
- Yerli üretim

- Insulated or uninsulated facade options
- Thermal roofing system
- Equipment options
- Domestic Production





T-Line Endüstriyel Çadır Serisi üretim tesisleri, fabrikalar, depolama alanları gibi geniş kapsamlı ihtiyaçlar için tasarlanmış, ekonomik endüstriyel tip kalıcı çadır sistemleridir. Hiçbir malzeme kaybı olmadan farklı bir alana taşınıp tekrar kurulabilmektedir. T-Line Endüstriyel Çadır Serisi 10 metre eninden başlayan temiz açıklıklı (kolonsuz) yapılar sunmaktadır. 5 metrelik aks mesafeleri ile sınırsız olarak uzatılabilmektedir.

T-Line Endüstriyel Çadır Serisi'nin konstrüksiyonu çelik profillerden meydana gelirken, cephe kaplamaları her iki tarafı PVC kaplı polyester kumaş, trapez sac panel veya sandviç panel tercih edilebilmektedir. Kapı tercihlerinde perde tipi branda kapı, hızlı açılır kapı, personel kapısı, seksiyonel kapı, körük sistemleri vb. kapı tercihleri uygulanabilmektedir.

T-Line Industrial Series are economical industrial type of permanent tent systems designed for a wide range of needs such as production facilities, factories and storage areas. It can be moved to a different area and re-installed without any material loss. T-Line Industrial Series offer clear span (columnless) structures starting from 10 meters wide. It can be extended unlimitedly with axle distances of 5 meters.

While the construction of T-Line Industrial Tent Series consist of anodized aluminum profiles, for facade cladding, PVDF coated tarpaulin, trapezoidal sheet metal, ISO panel or glass panel can be preferred. In door preferences, tarpaulin sliding gate, steel sliding gate, roller shutter gate, personnel door, sectional gate, loading dock etc. can be applied.



# T-LINE

## Geniş Kullanım Alanı Sağlayan Ekonomik Çözüm

The Economical Solution for Wide Range of Uses



### Fiyat - Performans Ürünü

/ High Cost-effectiveness



### Hava Koşullarına Karşı İdeal Koruma

/ Ideal Weather Protection



### Kalıcı Yapı Olarak Kullanılabilme

/ Permanent Usable



### Geniş Kullanım Alanı

/ Wide Range of Uses



### Yerli Üretim

/ Domestic Production

### Çatı Seçenekleri / Roofing Options

- Thermo-Roof Çatı Sistemi / Insulating Thermal Roofing

### Rüzgar ve Kar Yüğü / Wind and Snow Load

140 km/h - 75 kg/m<sup>2</sup>

### Çatı Eğimi / Roof Pitch

15°

### Cephe Seçenekleri / Facade Options

- RÖDER No:1 PVDF Kaplanmış Branda / RÖDER No: 1 PVDF Coated Tarpaulin
- Trapez Sac Panel / Trapezoidal Sheet Metal
- Sandviç Panel / ISO Panel (40 mm)

Açıklık / Span  
10m / 15m / 20m

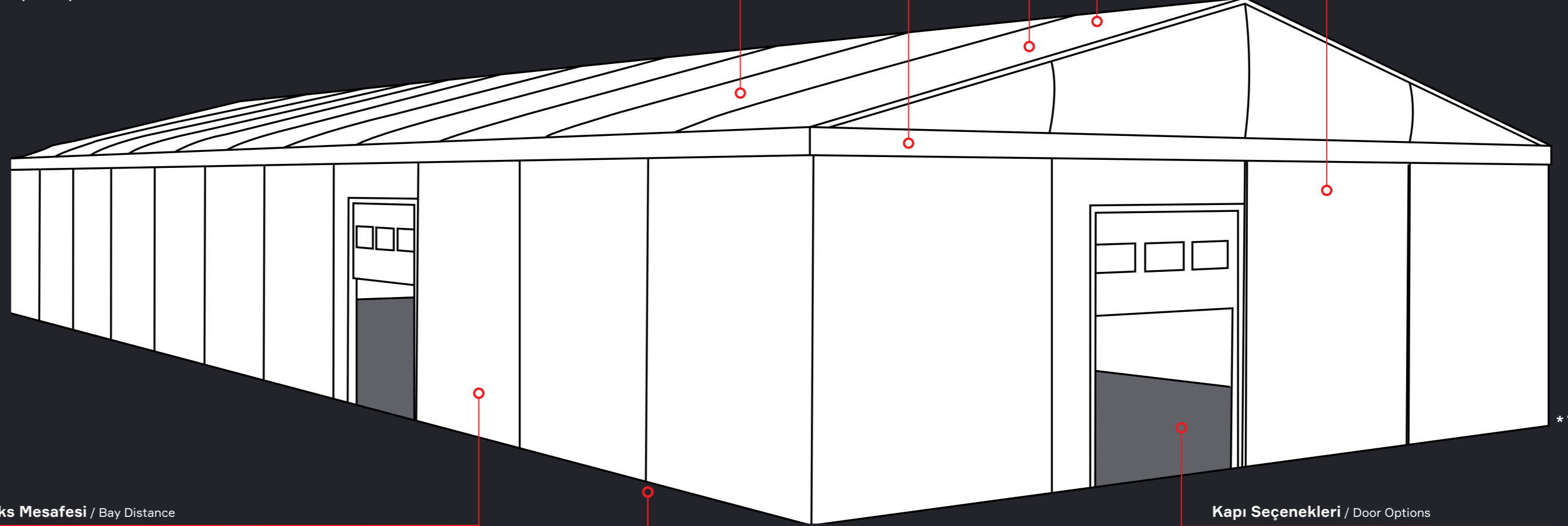

\* T-Line 20.00 m

### Aks Mesafesi / Bay Distance

5m

### Yan Yükseklik / Side Height

6.2m / 7.66m

### Kapı Seçenekleri / Door Options

- Perde Tipi Branda Kapı / Tarpaulin Sliding Gate
- Metal Sürgülü Kapı / Steel Sliding Gate
- Hızlı Açılır Kapı / Roller Shutter Gate
- Seksiyonel Kapı / Sectional Gate
- Yükleme Rampası / Loading Dock
- Personel Kapısı / Personnel Door



#### T-Line 10m

<b>Açıklık / Span</b>	<b>10m</b>
<b>Yan Yükseklik / Side Height</b>	<b>6.2m / 7.66m</b>
<b>Ana Profil / Main Profile</b>	<b>90 x 50 x 4/5mm</b>
<b>Maks. Uzunluk / Max. Length</b>	<b>Limit Yok / No Limit</b>

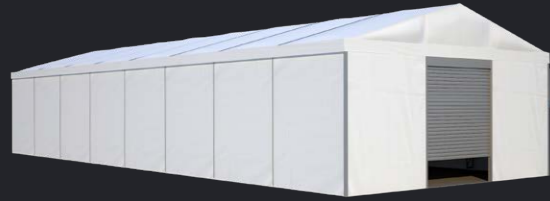

#### T-Line 15m

<b>Açıklık / Span</b>	<b>15m</b>
<b>Yan Yükseklik / Side Height</b>	<b>6.2m / 7.66m</b>
<b>Ana Profil / Main Profile</b>	<b>90 x 50 x 4/5mm</b>
<b>Maks. Uzunluk / Max. Length</b>	<b>Limit Yok / No Limit</b>



#### T-Line 20m

<b>Açıklık / Span</b>	<b>20m</b>
<b>Yan Yükseklik / Side Height</b>	<b>6.2m / 7.66m</b>
<b>Ana Profil / Main Profile</b>	<b>90 x 50 x 4/5mm</b>
<b>Maks. Uzunluk / Max. Length</b>	<b>Limit Yok / No Limit</b>





## ÇİĞİR KİMYA TEKİRDAĞ | TÜRKİYE | 2025

Sektör: Kimya / Sector: Chemistry



5.100 m<sup>2</sup>  
Alan  
Area



T-Line  
Serisi  
Series

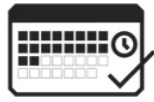

3 Hafta / Weeks  
Kurulum Süresi  
Installation Time



85 m  
Uzunluk  
Length

**EREN ENERJİ**  
ZONGULDAK | TÜRKİYE | 2022



**eren**  
ENERJİ

Sektör: Enerji / Sector: Energy



2.400 m<sup>2</sup>  
**Alan**  
Area

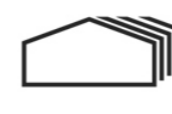

**T-Line**  
**Serisi**  
Series



2 Hafta / Weeks  
**Kurulum Süresi**  
Installation Time



120 m  
**Uzunluk**  
Length

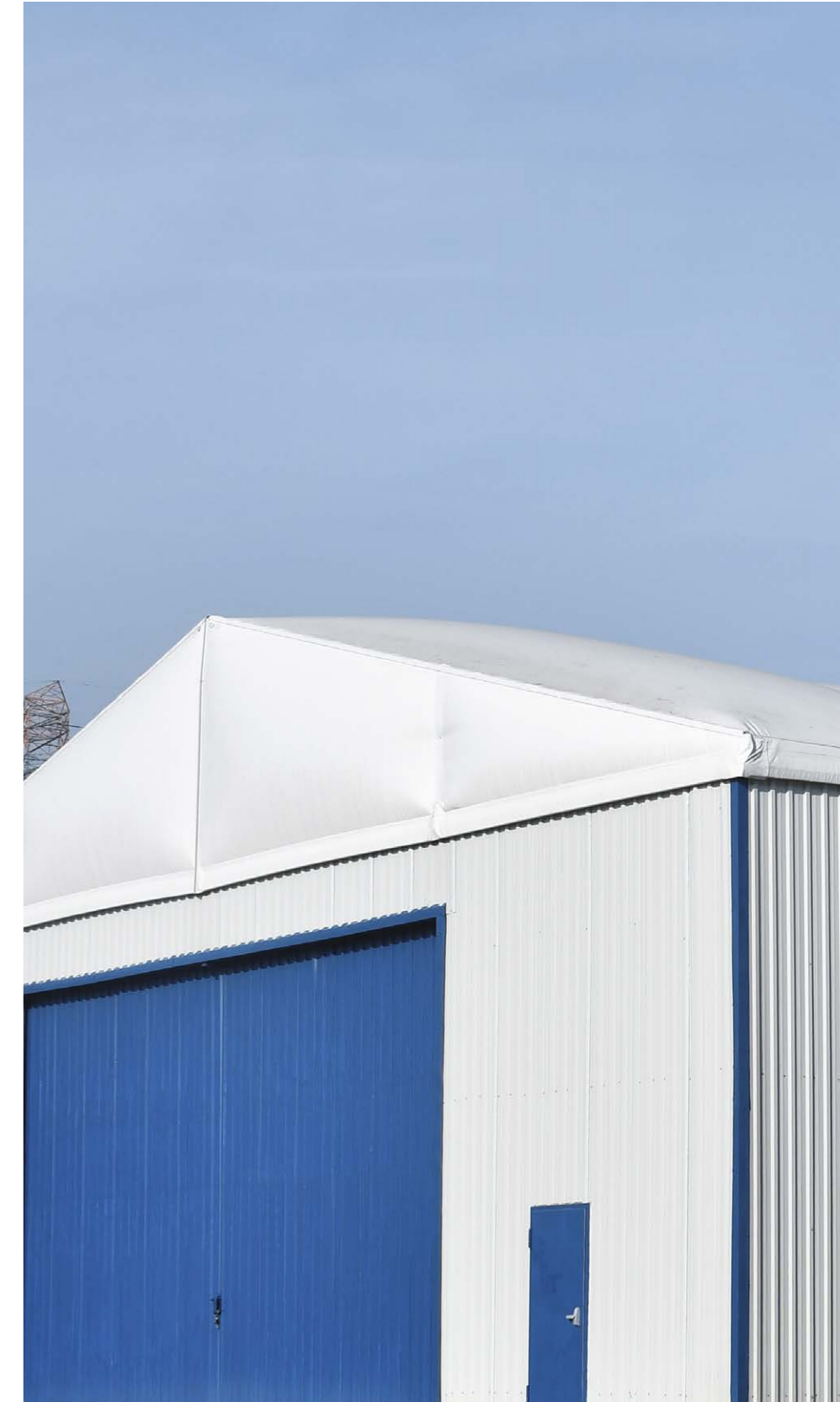



 TAHİNCİOĞLU

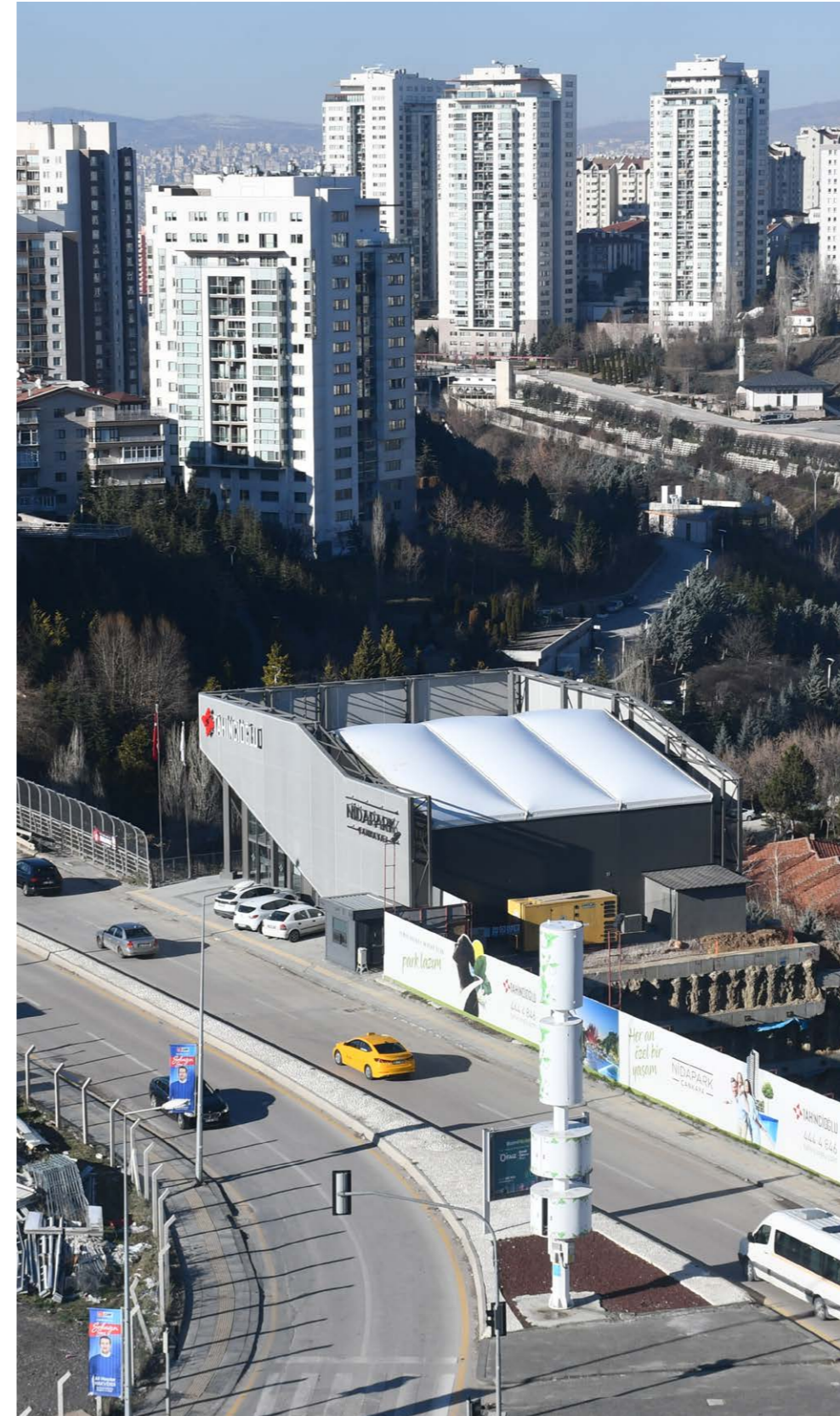

## TAHİNCİOĞLU ANKARA | TÜRKİYE | 2023

Sektör: İnşaat / Sector: Construction



300 m<sup>2</sup>  
Alan  
Area



T-Line  
Serisi  
Series

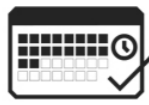

2 Hafta / Weeks  
Kurulum Süresi  
Installation Time



15 m  
Uzunluk  
Length



## TUBORG-CARLSBERG İZMİR | TÜRKİYE | 2023

Sektör: İçecek / Sector: Beverage



4.000 m<sup>2</sup>

Alan  
Area

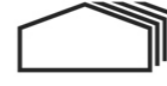

T-Line

Serisi  
Series



3 Hafta / Weeks

Kurulum Süresi  
Installation Time



200 m

Uzunluk  
Length





**Erikli**  
DOĞAL KAYNAK SUYU



## ERİKLİ NESTLE BURSA | TÜRKİYE | 2015

Sektör: İçecek / Sector: Beverage



4.200 m<sup>2</sup>  
Alan  
Area



T-Line  
Serisi  
Series

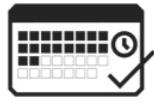

4 Hafta / Weeks  
Kurulum Süresi  
Installation Time

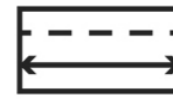

210 m  
Uzunluk  
Length

**OYAK RENAULT**  
OTOMOBİL FABRİKALARI



## RENAULT BURSA | TÜRKİYE | 2017

Sektör: Otomotiv / Sector: Automotive



4.000 m<sup>2</sup>

Alan  
Area

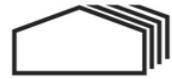

T-Line

Serisi  
Series

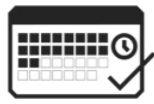

3 Hafta / Weeks

Kurulum Süresi  
Installation Time



200 m

Uzunluk  
Length





ANADOLU ISUZU



## ANADOLU ISUZU KOCAELİ | TÜRKİYE | 2014

Sektör: Otomotiv / Sector: Automotive



800 m<sup>2</sup>  
Alan  
Area



T-Line  
Serisi  
Series

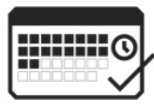

2 Hafta / Weeks  
Kurulum Süresi  
Installation Time



40 m  
Uzunluk  
Length



**KRONE** İZMİR | TÜRKİYE | 2022



1.600 m<sup>2</sup>

**Alan**  
Area

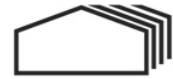

T-Line

**Serisi**  
Series

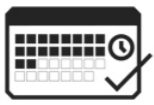

1 Hafta / Weeks

**Kurulum Süresi**  
Installation Time



80 m

**Uzunluk**  
Length

**DALGAKIRAN**  
KOMPRESÖR



## DALGAKIRAN KOCAELİ | TÜRKİYE | 2024

Sektör: İmalat / Sector: Production

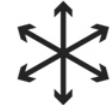

600 m<sup>2</sup>

Alan  
Area



T-Line

Serisi  
Series

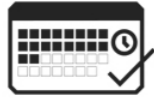

1 Hafta / Weeks

Kurulum Süresi  
Installation Time



40 m

Uzunluk  
Length

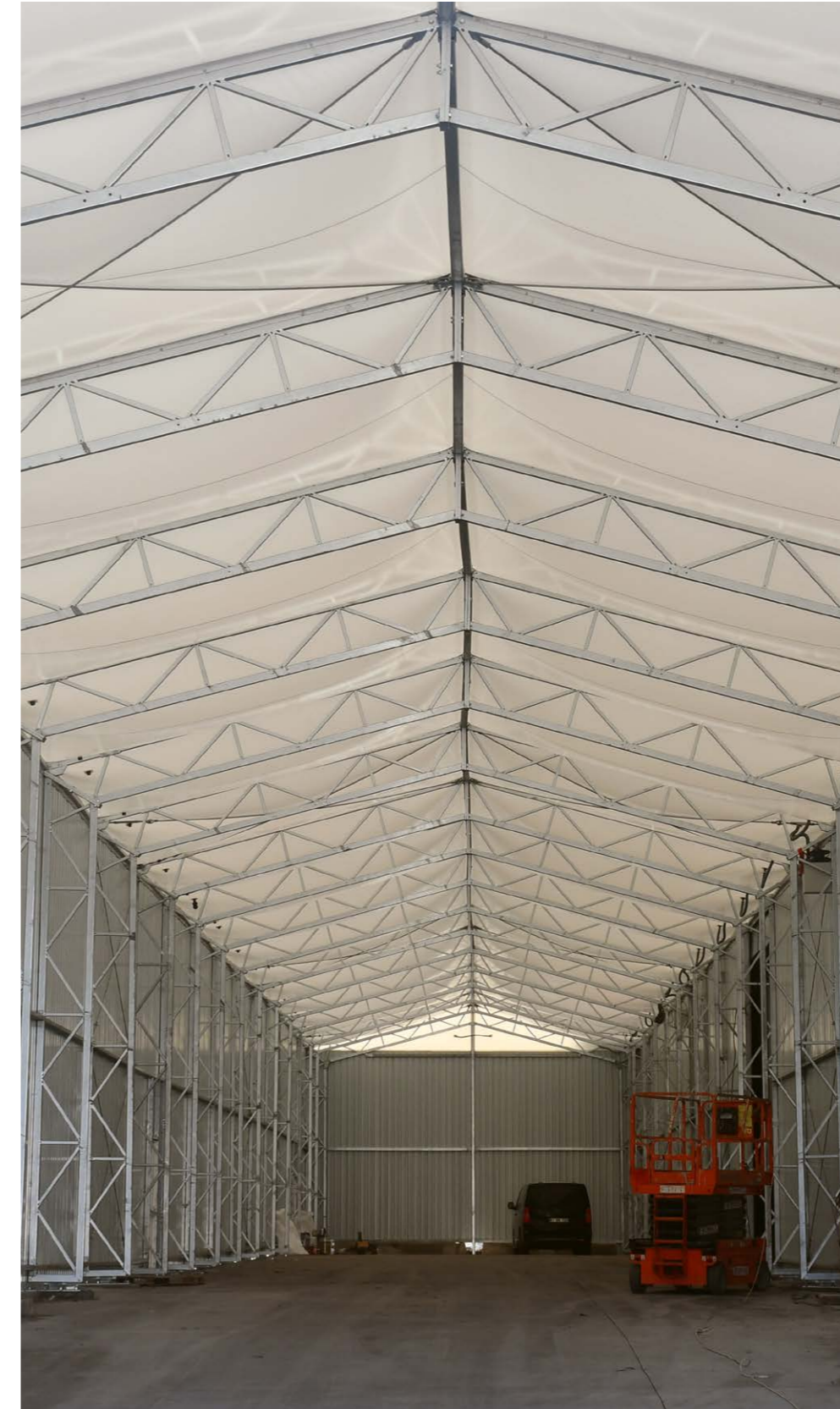

## VE-GE İZMİR | TÜRKİYE | 2025

Sektör: İmalat / Sector: Production



3.150 m<sup>2</sup>

Alan  
Area



T-Line

Serisi  
Series

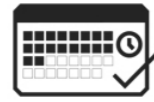

3 Hafta / Weeks

Kurulum Süresi  
Installation Time



210 m

Uzunluk  
Length



## 3M BURSA | TÜRKİYE | 2018

Sektör: İmalat / Sector: Production



1.275 m<sup>2</sup>

Alan  
Area



T-Line

Serisi  
Series

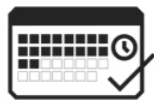

2 Hafta / Weeks

Kurulum Süresi  
Installation Time



85 m

Uzunluk  
Length





**RÖDER Yapı Sistemleri San.Tic.Ltd.Şti.**

**Merkez | Head Office**

Sahrayıcedit Mah., Atatürk Cad., No: 69,  
Mesa Koz Kule Bloğu, Kat:9, D:122-123,  
Kadıköy, İstanbul, Türkiye  
Tel +90 (216) 340 89 10  
Fax +90 (216) 340 89 15  
info@roder.com.tr  
www.roder.com.tr

**Fabrika | Factory**

Yakabaşı Köyü, Yakabaşı Mevkii,  
Gümüşova OSB Sokak, No:95, İç Kapı No:1,  
Gümüşova, Düzce, Türkiye  
Tel +90 (380) 745 13 36  
Fax +90 (380) 745 13 40  
info@roder.com.tr

